

#### 2 VALVE MANIFOLD

#### M2H

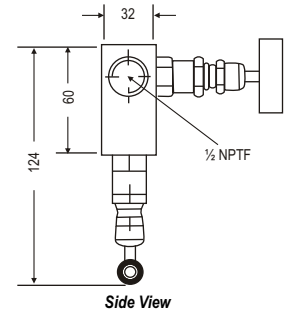
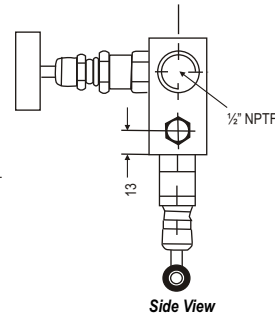
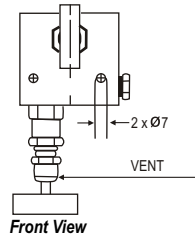
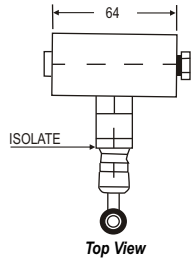
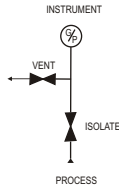

#### Standard connection

Product	Process side	Instrument side	Vent/Test
M2H	1/2" NPT female	1/2" NPT female	1/4" NPT female

\* Working Pressure : 6000 psi

#### M2T

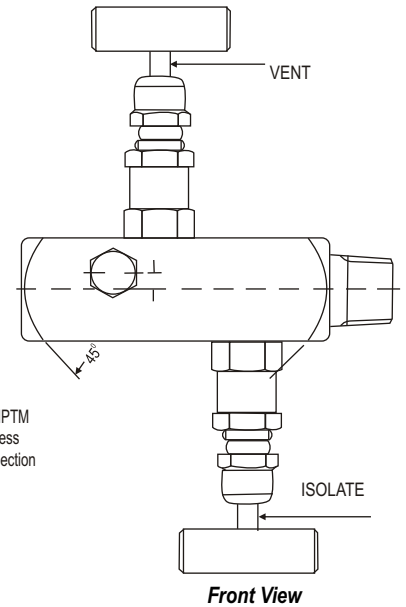
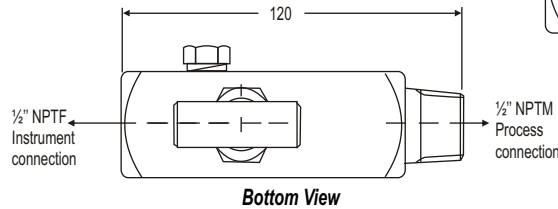
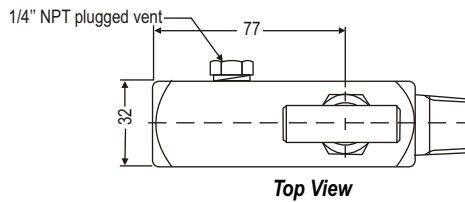
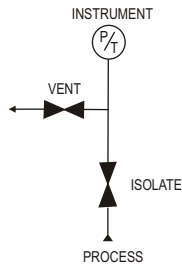

#### Standard connection

Product	Process side	Instrument side	Vent/Test
M2T	1/2" NPT male	1/2" NPT female	1/4" NPT female

\* Working Pressure : 6000 psi

#### M2A

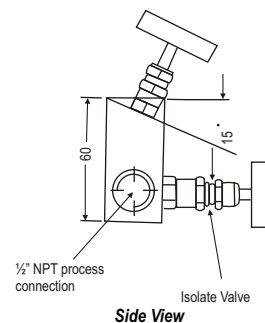
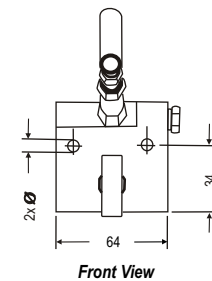
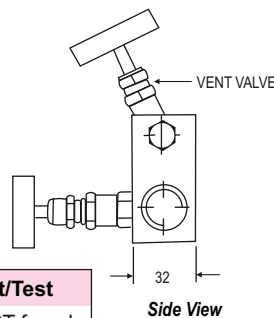
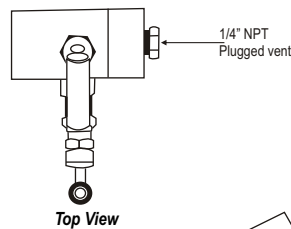
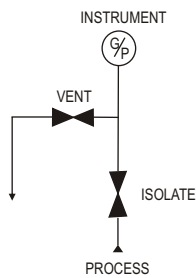

#### Standard connection

Product	Process side	Instrument side	Vent/Test
M2A	1/2" NPT female	1/2" NPT female	1/4" NPT female

\* Working Pressure : 6000 psi

## HOW TO ORDER

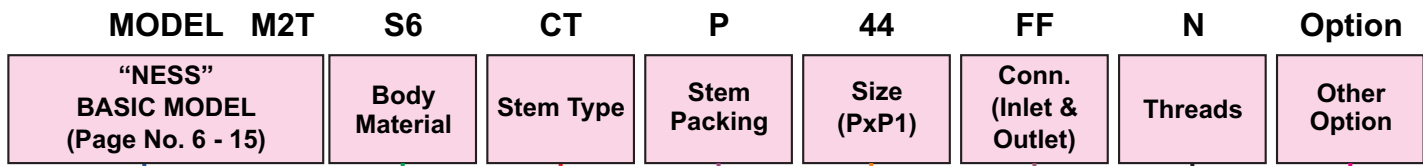

**Select From Respective Type**

Body Material	Code
CARBON STEEL	CS
SS 316	S6
SS 304	S4
SS 316L	S6L
MONEL 400	MN
MONEL 500	M5
HASTELLOY C	HT

Stem Type	Code
WITH SS NEEDLE	CT
WITH DELRIN SOFT NEEDLE	DS

Stem Packing	Code
PTFE	P
GRAFOIL	G

Size (PxP1)	Code *
1" x 1"	66
3/4" x 3/4"	55
1/2" x 1/2"	44
3/8" x 3/8"	33
1/4" x 1/4"	22
1/8" x 1/8"	11
1/2" x FLANGE	4F
1/4" x FLANGE	2F
FLANGE x FLANGE	FF

\* Please Refer detail connection size (P X P1) Table on Page No. 5

Conn. (Inlet & Outlet)	Code
Female x Female	FF
Male x Female	MF
Male x Male	MM
Socket Weld	SW
Male x Female Rotating	MR
Female x Female Rotating	FR
Female x Flange (54mm)	FD
Flange x Flange	DD

Threads	Code
NPT (ANSI B 1.20.1)	N
BSPP (BS 2779 / ISO228/1)	B
BSPT (BS21 / ISO7/1)	T

Other Options	Code
Compliance to NACE standard MR-0175.	NC
For Oxygen service, valves are supplied cleaned, degreased and suitably packed.	OS
Material test certificate	MC
Hydro test certificate	HC
Mounting bolts (7/16" UNF) in carbon steel (Model:MBC - M45,MBC - M25)	MBC
Mounting bolts (7/16" UNF) in Stainless Steel (Model:MBS - M45, MBS - M25)	MBS
Anti Tamper valve	ATV
Anti Tamper key	ATK
PTFE Ring For Flange Seal	FSP
Grafoil Ring For Flange Seal	SFG

### \*Connection Size (P X P1)

MODEL Size (P X P1)	CODE	NEEDLE VALVE				BALL VALVE
		VN3	VN6	VC6	VB6	BV6
1" x 1"	66	x	✓	✓	✓	✓
3/4" x 3/4"	55	x	✓	✓	✓	✓
1/2" x 1/2"	44	✓	✓	✓	✓	✓
3/8" x 3/8"	33	✓	✓	✓	✓	✓
1/4" x 1/4"	22	✓	✓	✓	✓	✓
1/8" x 1/8"	11	✓	x	x	x	x
1/2" x FLANGE	4F	x	x	x	x	x
1/4" x FLANGE	2F	x	x	x	x	x
FLANGE x FLANGE	FF	x	x	x	x	x

\* Note:

✓ - Available  
x - Not Available

MODEL Size (P X P1)	CODE	2 WAY MANIFOLD						
		M2H	M2T	M2A	M2M	M2S	M2F	M2Q
1" x 1"	66	x	x	x	x	x	x	x
3/4" x 3/4"	55	x	x	x	x	x	x	x
1/2" x 1/2"	44	✓	✓	✓	✓	✓	x	x
3/8" x 3/8"	33	✓	✓	✓	✓	✓	x	x
1/4" x 1/4"	22	✓	✓	✓	✓	✓	x	x
1/8" x 1/8"	11	x	x	x	x	x	x	x
1/2" x FLANGE	4F	x	x	x	x	x	✓	✓
1/4" x FLANGE	2F	x	x	x	x	x	✓	✓
FLANGE x FLANGE	FF	x	x	x	x	x	x	x

MODEL Size (P X P1)	CODE	3 WAY MANIFOLD						
		M3S	M3M	M3D	M3A	M3Q	M3P	M3H
1" x 1"	66	x	x	x	x	x	x	x
3/4" x 3/4"	55	x	x	x	x	x	x	x
1/2" x 1/2"	44	✓	✓	✓	x	x	x	x
3/8" x 3/8"	33	x	x	x	x	x	x	x
1/4" x 1/4"	22	✓	✓	x	x	x	x	x
1/8" x 1/8"	11	x	x	x	x	x	x	x
1/2" x FLANGE	4F	x	x	x	✓	✓	✓	x
1/4" x FLANGE	2F	x	x	x	✓	✓	✓	x
FLANGE x FLANGE	FF	x	x	x	x	x	x	✓

MODEL Size (P X P1)	CODE	5 WAY MANIFOLD									
		M5A	M5G	M5D	M5Q	M5R	M5S	M5P	M5N	M5K	M5H
1" x 1"	66	x	x	x	x	x	x	x	x	x	x
3/4" x 3/4"	55	x	x	x	x	x	x	x	x	x	x
1/2" x 1/2"	44	✓	✓	✓	✓	✓	x	x	x	x	x
3/8" x 3/8"	33	x	x	x	x	x	x	x	x	x	x
1/4" x 1/4"	22	✓	✓	✓	✓	✓	x	x	x	x	x
1/8" x 1/8"	11	x	x	x	x	x	x	x	x	x	x
1/2" x FLANGE	4F	x	x	x	x	x	✓	✓	✓	✓	x
1/4" x FLANGE	2F	x	x	x	x	x	✓	✓	✓	✓	x
FLANGE x FLANGE	FF	x	x	x	x	x	x	x	x	x	✓